

SG 4840

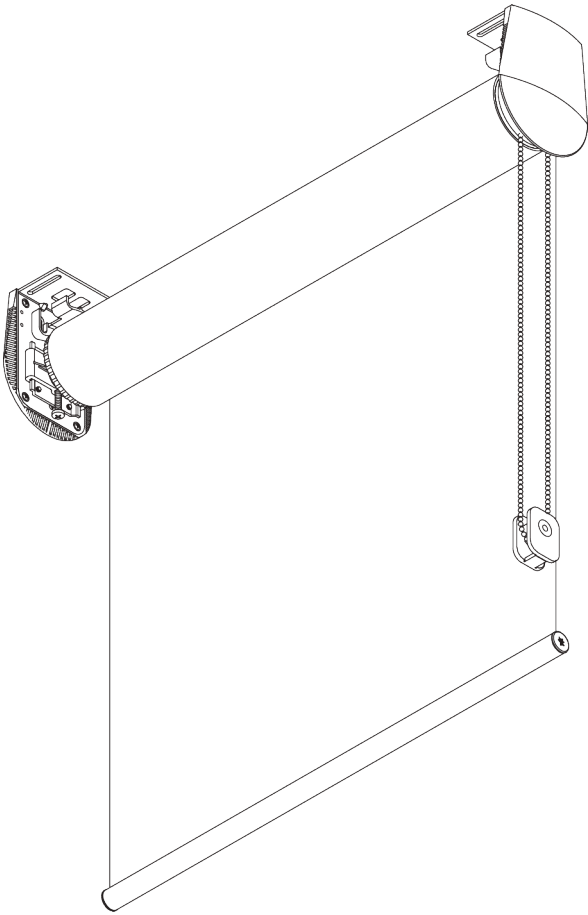
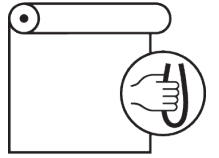

INFORMATION PRODUIT

- **Mode de commande :** Chaînette
- **Gamme:** L
- **Installation:** Plafond, Murale, Encastré
- **Couleurs:** Blanc RAL 9016 ou Aluminium, couleurs spéciales possibles
- **Tissus:** Se référer à la collection tissu Silent Gliss

Caractéristiques:

- Chaînette en acier inoxydable
- Supports en acier inoxydable, réglables

SPÉCIFICATION SYSTÈME

A. DIMENSIONS SYSTÈME



Profil SG 4901: 4 m
Profil SG 4957: 5 m



50 cm

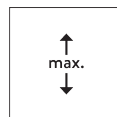

Profil SG 4901: 6 m
Profil SG 4957: 3.75 m

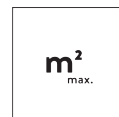

15 m²

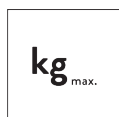

Profil SG 4901: 12.5 kg
Profil SG 4957: 9.5 kg

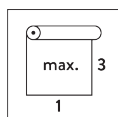

Rapport largeur / hauteur
recommandé
max. 1:3

Surface max.

		A →								
		2 m	2.5 m	3 m	3.5 m	4 m	4.5 m	5 m		
B ↓	2 m	●	●	●	●	○	○	○		
	2.5 m	●	●	●	●	○	○	○		
	3 m	●	●	●	●	○	○	○		
	3.5 m	●	●	●	●	○				
	4 m	●	●	●	●					
	4.5 m	●	●	●						
	5 m	●	●	●						
	5.5 m	●	●		max. 15 m ²					
6 m	●	●								

● SG 4901 (ø 80 mm)
○ SG 4957 (ø 110 mm)

B. PROFIL

Information profil

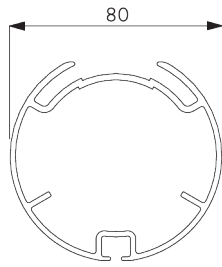

SG 4901

Profil ø 80 mm

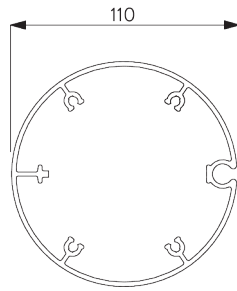

SG 4957

Profil ø 110 mm

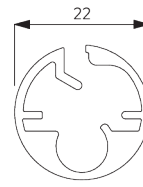

SG 10760

Barre de lestage

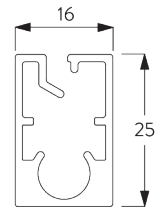

SG 10770

Barre de lestage

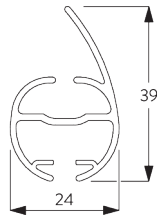

SG 4903

Barre de lestage

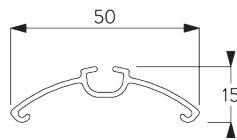

SG 4902

Profil

C. PRISE DE MESURE

y compris cache support
(15 mm)

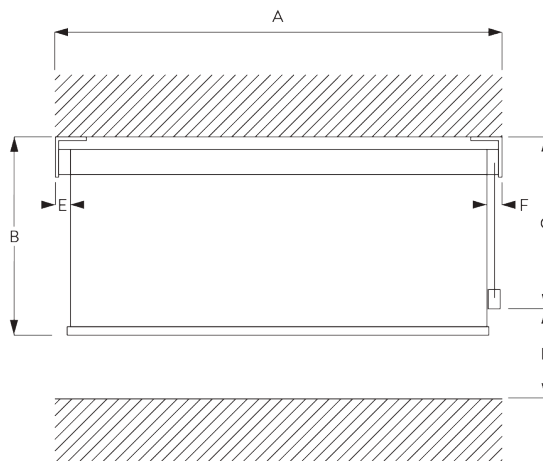

A : Largeur du système

B : Hauteur du système

C : Longueur de la chaînette

D : Sécurité SG 10731. min. 150 cm du sol

Profil SG 4901 (ø 80 mm)

E : Passage de lumière: 44 mm

F : Passage de lumière côté manoeuvre: 40 mm

Profil SG 4957 (ø 110 mm)

E : Passage de lumière: 42 mm

F : Passage de lumière côté manoeuvre: 42 mm

Note:

Toutes les dimensions comprennent 15 mm pour les caches supports par côté!

INSTALLATION

A. INSTRUCTION DE POSE

Pour des informations détaillées, se référer au site web
Silent Gliss.

Points de fixation



*30 mm sans cache support

*43 mm avec cache support

**Supports ajustables
pour réglage vertical**

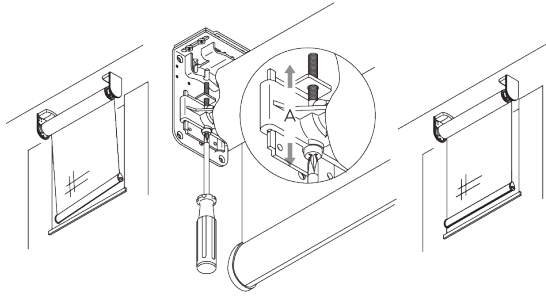

Ajustement vertical du tissu par rapport au cadre de la fenêtre.

**B. FIXATION
PLAFOND**

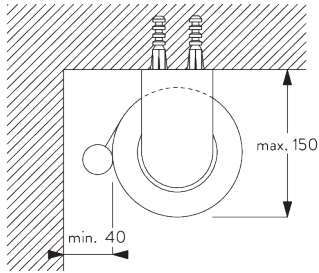

Profil SG 4901 (ø 80 mm)

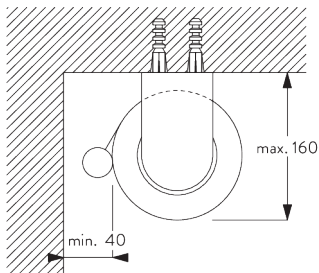

Profil SG 4957 (ø 110 mm)

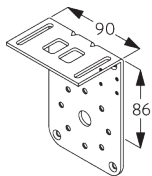

SG 4904
Support (131mm)

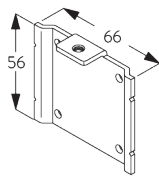

SG 4906
Support

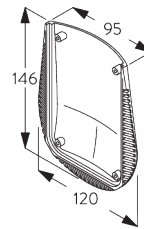

SG 4956
Cache support

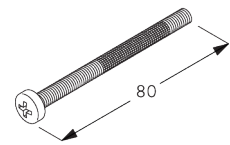

SG 4966
Vis spéciale

**C. FIXATION
MURALE**

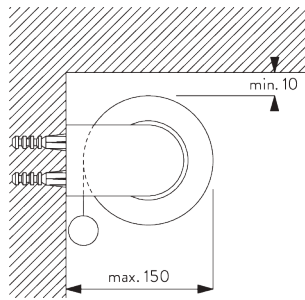

Profil SG 4901 (ø 80 mm)

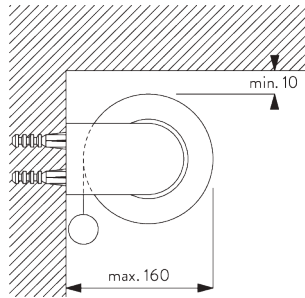

Profil SG 4957 (ø 110 mm)

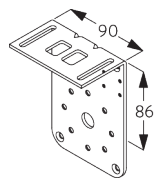

SG 4904
Support (131mm)

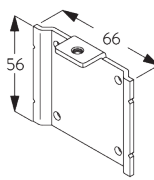

SG 4906
Support

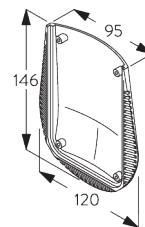

SG 4956
Cache support

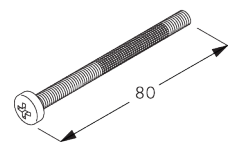

SG 4966
Vis spéciale

**D. FIXATION
ENCASTRÉE**

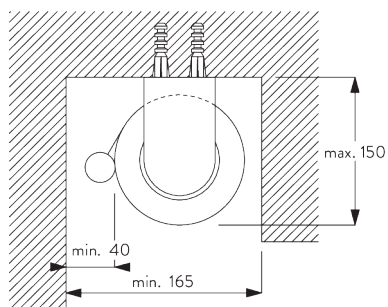

Profil SG 4901 (ø 80 mm)

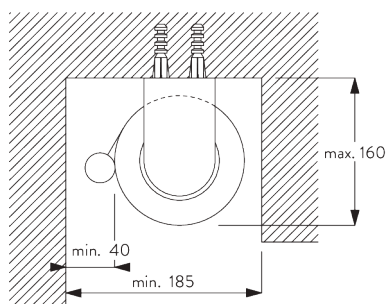

Profil SG 4957 (ø 110 mm)

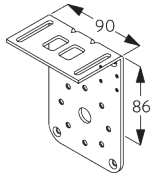

SG 4904
Support (131mm)

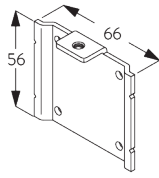

SG 4906
Support

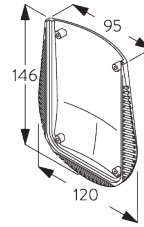

SG 4956
Cache support

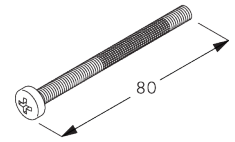

SG 4966
Vis spéciale

**E. FIXATION AVEC
OPTION DE
GUIDAGE**

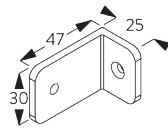
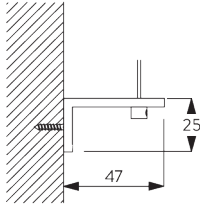

SG 3036
Equerre 47 mm

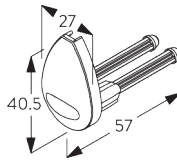

SG 4944
Embout pour barre de lestage
(guidage)

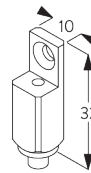

SG 4946
Support guide supérieur
latérale

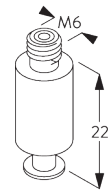

SG 4947
Support guide inférieur
latérale

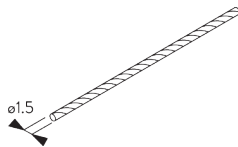

SG 4948
Câble de guidage \varnothing 1.5 mm

OPTIONS SYSTÈME

**A. DÉROULEMENT
DE LA TOILE**

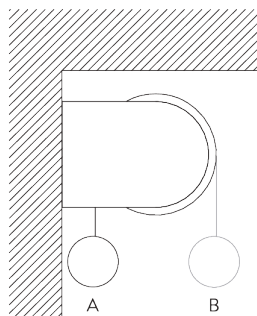
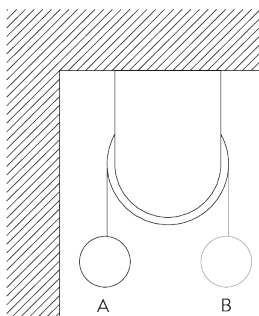

A: Déroulement au plus près de la fenêtre (standard)
B: Déroulement vers l'intérieur de la pièce (option)

B. GUIDAGE

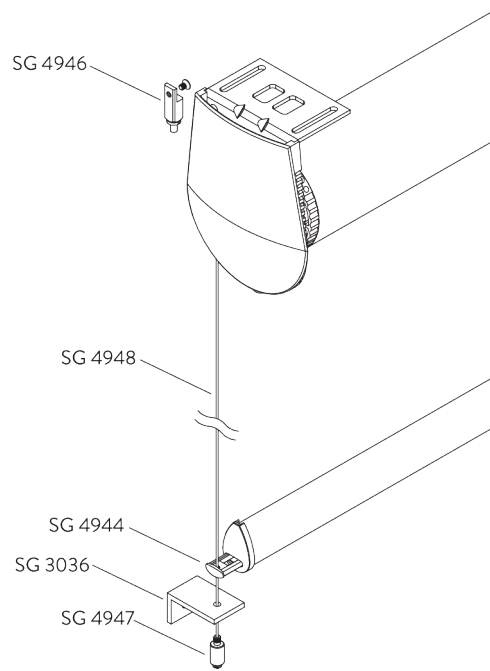

Accessoires complémentaires :

- 2x SG 3036 Support 47 mm
- 2x SG 4944 Embout pour barre de lestage (guidage)
- 2x SG 4946 Support guide supérieur latérale
- 2x SG 4947 Support guide inférieur latérale
- 2x SG 4948 Câble de guidage diam 1.5 mm

Note:

- Le passage de lumière latéral augmente avec l'option de guidage
- Guidage sur pente maxi de 15°

C. ACCROCHE DES PLATINES DE POSE

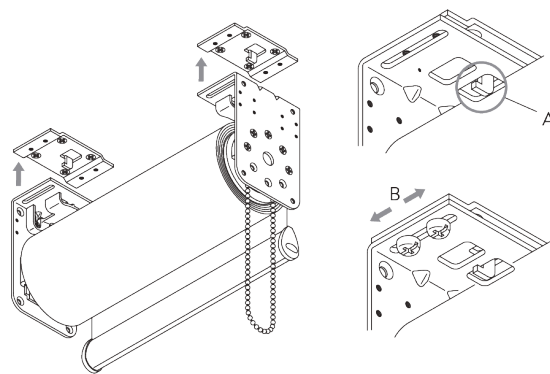

A: Le crochet de la platine SG 4972 supporte le poids du store

B: Support ajustable latéralement sur 18 mm

D. ARRÊT DE FIN DE COURSE AJUSTABLE

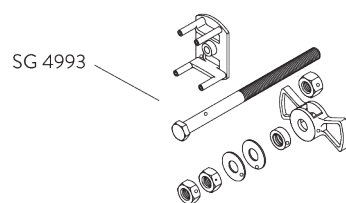

ACCESSOIRES

A. ACCESSOIRES STANDARDS

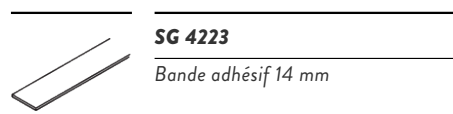

SG 4223

Bande adhésif 14 mm



SG 4226

Bande adhésif 30 mm



SG 4845

Chaîne métallique ø 4.5 mm



SG 4901

Profil ø 80 mm



SG 4902

Profil

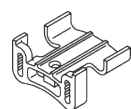

SG 4908

Arrêt

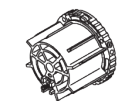

SG 4914

Support

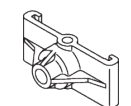

SG 4915

Support

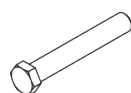

SG 4939

Axe



SG 4941

Ensemble d'engrenages

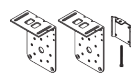

SG 4949

Set supports



SG 4956

Cache support

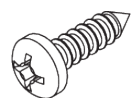

SG 10503

Vis 3.5x13

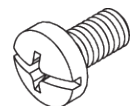

SG 10505

Vis Freedrive M4x8

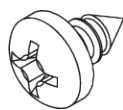

SG 10507

Vis 3.5x6.5

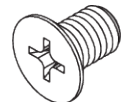

SG 10509

Vis M5x8



SG 10731

Poulie de sécurité pour chaînette & cordon



SG 10760

Barre de lestage



SG 10761

Embout pour barre de lestage

B. ACCESSOIRES EN OPTION

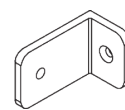

SG 3036

Équerre 47 mm



SG 4903

Barre de lestage



SG 4909

Poulie

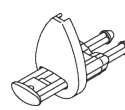

SG 4944

Embout pour barre de lestage (guidage)

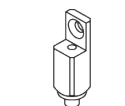

SG 4946

Support guide supérieur latérale

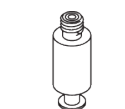

SG 4947

Support guide inférieur latérale



SG 4948

Câble de guidage ø 1.5 mm

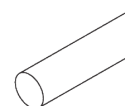

SG 4951

Contrepoids acier



SG 4957

Profil ø 110 mm

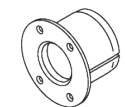

SG 4958

Support

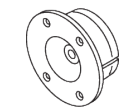

SG 4961

Support

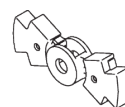

SG 4965

Arrêt

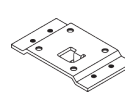

SG 4972

Support

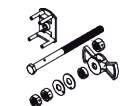

SG 4993

Fin de course

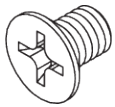

SG 10502

Vis M4x6

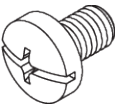

SG 10504

Vis M5x8

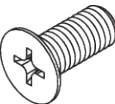

SG 10508

Vis M5x12

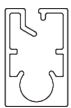

SG 10770

Barre de lestage



SG 10771

Embout pour barre de lestage



SG 11178

Embout pour barre de lestage
