

SG 7620

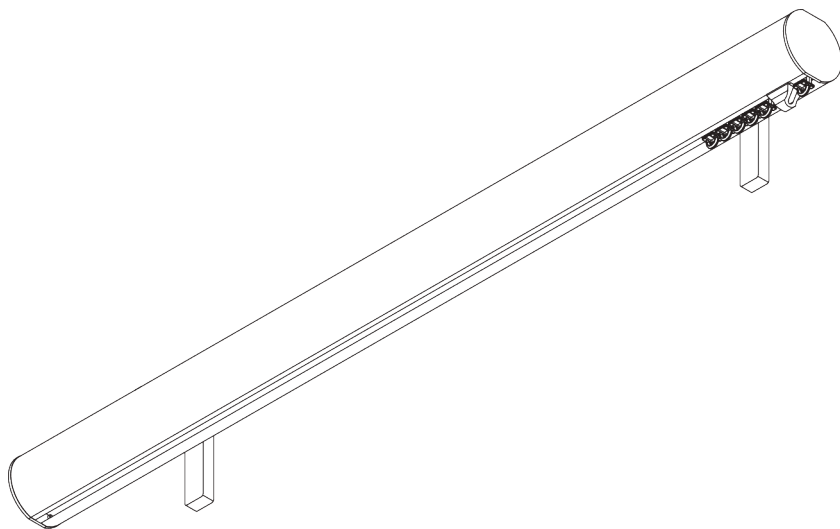
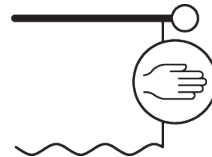

INFORMATION PRODUIT

- **Mode de commande:** Tirage main
- **Gamme:** M - L
- **Installation:** Plafond, murale
- **Couleurs:** Blanc RAL 9016, couleurs spéciales possibles
- **Tissus:** Se référer à la collection tissu Silent Gliss

Caractéristiques:

- Glisseurs Bi-Composants
- Option Glisseurs Wave Bi-Composants
- Couleurs assorties pour embouts et supports
- Collection d'embouts de finition
- Cintrable

SPÉCIFICATION SYSTÈME

A. PROFIL

Profil et information de cintrage

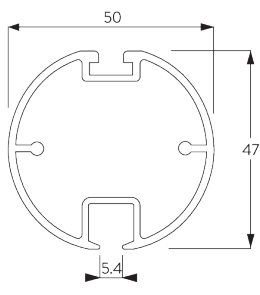

SG 11609

Profil

✓ Rayon:
>50 cm

B. PRISE DE MESURE

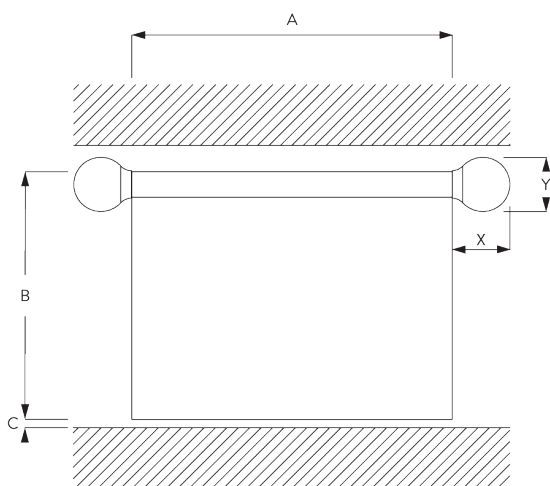

A: Largeur système sans les embouts décoratifs







B: Hauteur système

C: Distance entre bas du rideau et le sol

X: Largeur des embouts décoratifs

Y: Hauteur des embouts décoratifs

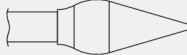
Dimensions des embouts décoratifs

		50 mm	
		X	Y
	SG 11605	2	51
	SG 11651	10	56
	SG 11652	24	75
	SG 11776	90	85
	SG 11777	165	70
	SG 11778	32	130
	SG 11779	30	100

INSTALLATION

A. INSTRUCTION DE POSE

Pour des informations détaillées, se référer au site web Silent Gliss.

Points de fixation

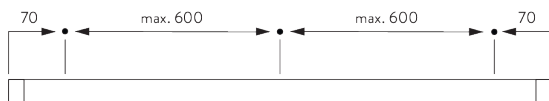

B. FIXATION PLAFOND

Support Top Fix SG 11668

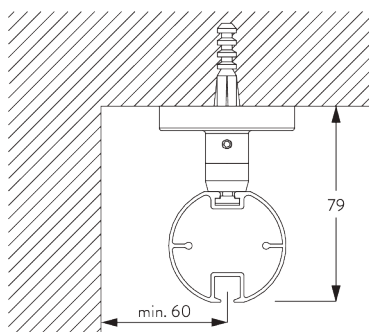

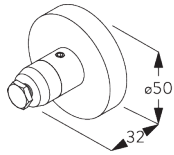

SG 11668

Support Top Fix

**Mini suspension
SG 6175**

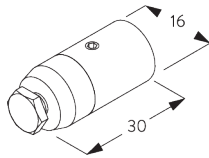
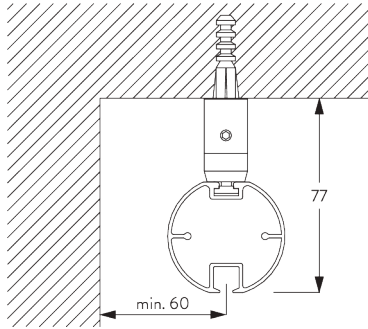

SG 6175

Mini suspension

**C. FIXATION
MURALE**

Smart Fix

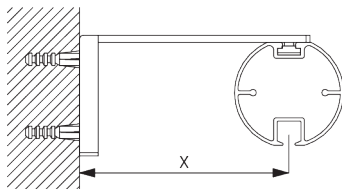

Smart Fix avec fente SG 11206 - SG 11208 et SG 6141:

Vis SG 10492 (M4x10) nécessaire.

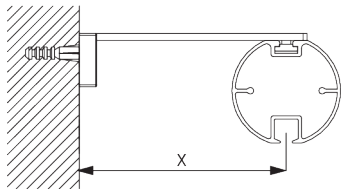

**Square Smart Fix avec fente SG 11216 - SG 11218
et SG 6141:**

Vis SG 10492 (M4x10) nécessaire.

Smart Fix	X mm
SG 11206 / SG 11216	51
SG 11207 / SG 11217	71
SG 11208 / SG 11218	91

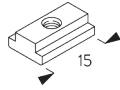

SG 6141
Ecrou fixation



SG 10492
Vis M4x8

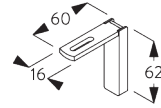

SG 11206
Smart Fix 60 mm avec fente

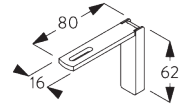

SG 11207
Smart Fix 80 mm avec fente

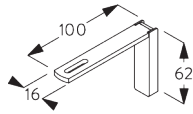

SG 11208
Smart Fix 100 mm avec fente

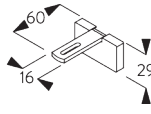

SG 11216
Square Smart Fix 60 mm avec fente

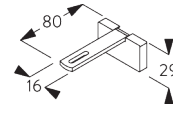

SG 11217
Square Smart Fix 80 mm avec fente

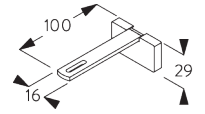

SG 11218
Square Smart Fix 100 mm avec fente

Support design SG 11669

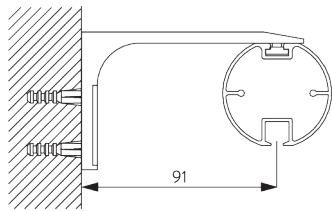

Vis SG 10492 (M4x8) nécessaire.
Recommandé pour les systèmes droits uniquement.

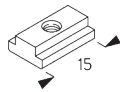

SG 6141
Ecrou fixation



SG 10492
Vis M4x8

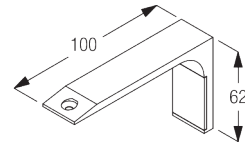

SG 11669
Support design

OPTIONS DÉSIGN & SYSTÈME

A. EMBOUTS



SG 11605



SG 11651



SG 11652

Embouts:

- SG 11605 Embout Flush 50 mm
- SG 11651 Embout Stud 50 mm
- SG 11652 Embout Design 50 mm

Note:

- Sans embouts décoratives, les profils sont fournis en standard avec l'embout Flush SG 11605 (gauche)
- Alternativement, les embouts Stud SG 11651 sont disponibles.

B. EMBOUTS DÉCORATIVES

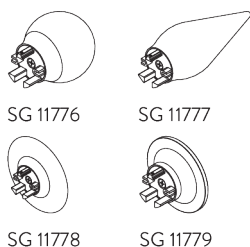

SG 11776

SG 11777



SG 11778



SG 11779

Les embouts décoratives sont des éléments décoratifs qui se fixent à l'extrémité des tringles:

- SG 11776 Ball 50 mm
- SG 11777 Spear 50 mm
- SG 11778 Ellipse 50 mm
- SG 11779 Taper 50 mm

C. WAVE

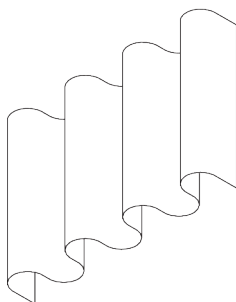

SG 11295

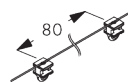

SG 11302

Composants standards:

- SG 11295 Vis d'arrêt
- SG 11302 Glisseurs Wave bi-composants 80 mm



SG 2255



SG 2256

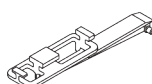

SG 6364



SG 6365

Composants en option:

- SG 2255 Frein
- SG 2256 Frein
- SG 6364 Extension Wave
- SG 6365 Crochet Wave
- SG 6366 Chariot Wave pour lance rideau
- SG 10430-34 Lance rideau
- SG 11303 Glisseur Wave bi-composants 60 mm

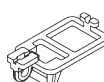

SG 6366

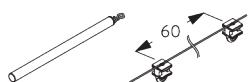

SG 10430-34 SG 11303

Composants de rideaux:

- SG 3582 Crochet
- SG 6349 Ruban Wave transparent
- SG 6363 Ruban à repasser
- SG 10075 Fil à plomb 50 gr/m
- SG 10076 Barre de lestage



SG 3582

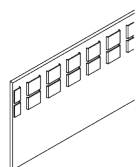

SG 6349

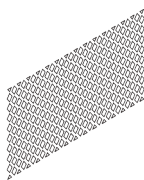

SG 6363

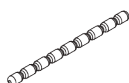

SG 10075



SG 10076

Paquet rideau Wave - Glisseur Bi-composants (standard)

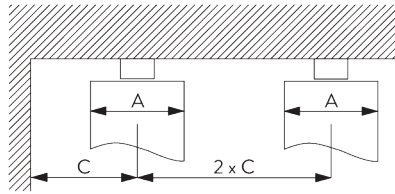
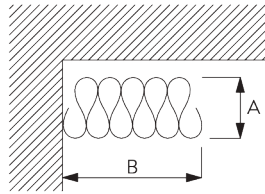

A = Epaisseur du Wave
 B = Largeur paquet rideau
 C = Ecartement minimum

Glisseur Bi-composants SG 11302	Nombre de poches entre crochets	Ampleur rideau Approximative	Epaisseur du Wave A	Largeur paquet rideau B*	Ecartement minimum C
80	6	~2.1	140	180 mm par ml de triangle	90
80	7	~2.3	160	180 mm par ml de triangle	100

Glisseur Bi-composants SG 11303	Nombre de poches entre crochets	Ampleur rideau Approximative	Epaisseur du Wave A	Largeur paquet rideau B*	Ecartement minimum C
60	4	~2.1	100	230 mm par ml de triangle	70
60	5	~2.3	120	230 mm par ml de triangle	80

*Largeur paquet rideau B lors de l'utilisation du bras d'extension SG 6364 augmente de 95 mm par rideau!

ACCESSOIRES

A. ACCESSOIRES STANDARDS



SG 6065

Fixateur avec oeillet

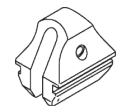

SG 6086

Ressort d'arrêt delrin



SG 6141

Écrou fixation



SG 10492

Vis M4x8

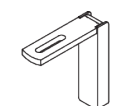

SG 11206

Smart Fix 60 mm avec fente



SG 11300

Glisseur Bi-composants



SG 11605

Embout Flush 50 mm

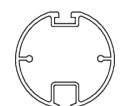

SG 11609

Profil

B. ACCESSOIRES EN OPTION

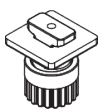

SG 2255

Frein

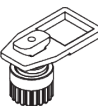

SG 2256

Frein



SG 3582

Agrafe Delrin



SG 3599

Crochet pour galon à froncer



SG 6094

Rouleur



SG 6098

Rouleur

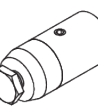

SG 6175

Mini suspension



SG 6283

Rouleur



SG 6349

Ruban Wave transparent



SG 6363

Ruban à repasser



SG 6364

Extension

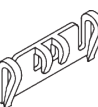

SG 6365

Crochet Wave

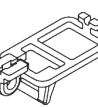

SG 6366

Chariot pour lance rideau

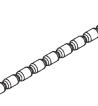

SG 10075

Fil à plomb 50 gr/m

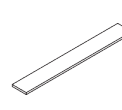

SG 10076

Barre de lestage

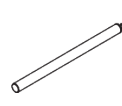

SG 10430

Lance rideau aluminium avec crochet, 50cm

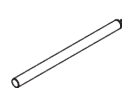

SG 10431

Lance rideau aluminium avec crochet, 75 cm

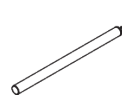

SG 10432

Lance rideau aluminium avec crochet, 100 cm

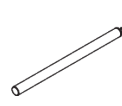

SG 10433

Lance rideau aluminium avec crochet, 125 cm

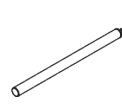

SG 10434

Lance rideau aluminium avec crochet, 150 cm

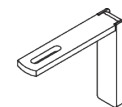

SG 11207

Smart Fix 80 mm avec fente

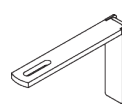

SG 11208

Smart Fix 100 mm avec fente

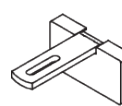

SG 11216

Square Smart Fix 60 mm avec fente

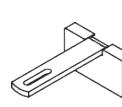

SG 11217

Square Smart Fix 80 mm avec fente

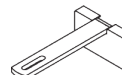

SG 11218

Square Smart Fix 100 mm avec fente

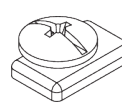

SG 11295

Arrêt



SG 11301

Glisseur Bi-composants en barrette

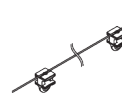

SG 11302

Glisseur Wave Bi-composants 80 mm

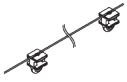

SG 11303

Glisseur Wave Bi-composants 60 mm



SG 11651

Embout Stud 50 mm



SG 11652

Embout Design 50 mm



SG 11668

Support Top Fix

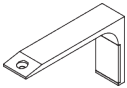

SG 11669

Support design

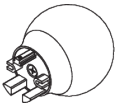

SG 11776

Ball 50 mm

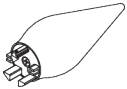

SG 11777

Spear 50 mm

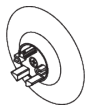

SG 11778

Ellipse 50 mm

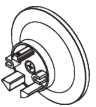

SG 11779

Taper 50 mm

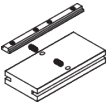

SG 11783

Pont de connexion
