

SG 6140M

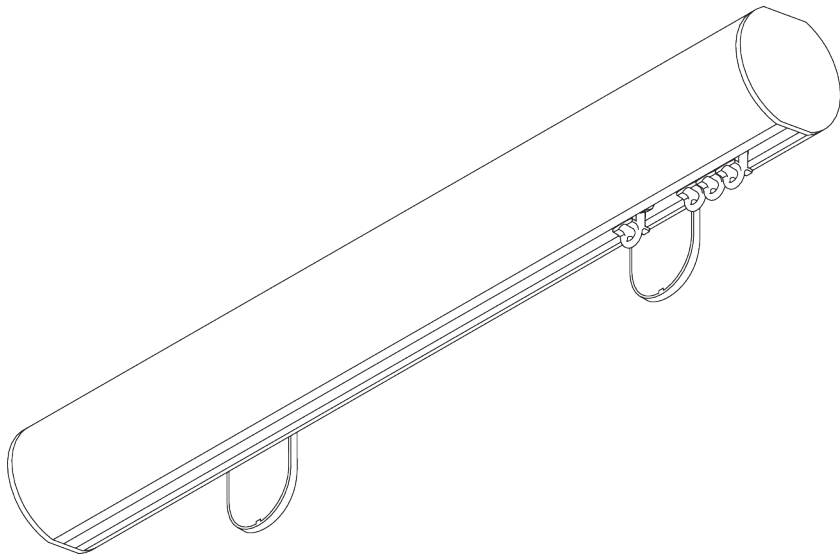
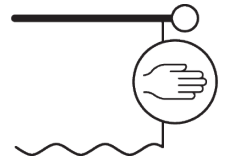

INFORMATION PRODUIT

- **Mode de commande:** Tirage main
- **Gamme:** M - L
- **Installation:** Plafond, murale
- **Couleurs:** Blanc RAL 9016 ou Aluminium, couleurs spéciales possibles
- **Tissus:** Se référer à la collection tissu Silent Gliss

Caractéristiques:

- Glisseurs bi-composants
- Option wave bi-composants
- Couleurs assorties pour embouts et supports
- Collection d'embouts de finition
- Cintrable

SPÉCIFICATION SYSTÈME

A. PROFIL

Profil et information de cintrage

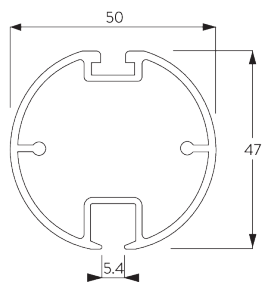

SG 20700

Profil 50 mm

✓ Rayon:
>50 cm

B. PRISE DE MESURE

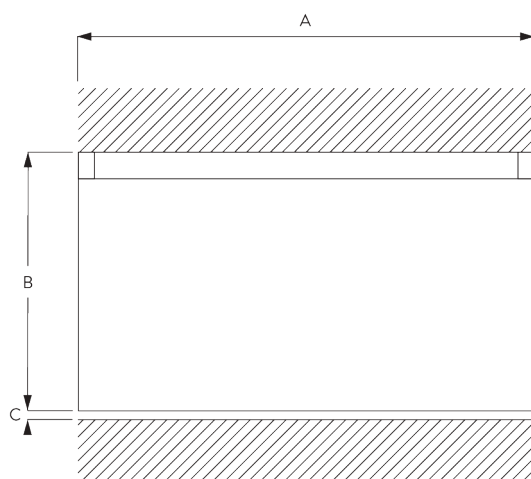

A: Largeur système avec les embouts décoratifs

B: Hauteur système

C: Distance entre bas du rideau et le sol

INSTALLATION

A. INSTRUCTION DE POSE

Pour des informations détaillées, se référer au site web Silent Gliss.

Points de fixation

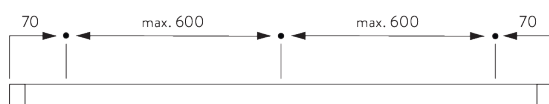

B. FIXATION
PLAFOND

Support SG 6152

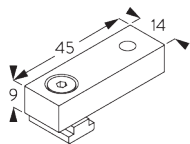
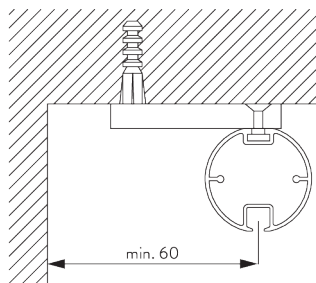

SG 6152
Support 9 mm

Support Top Fix
SG 20335

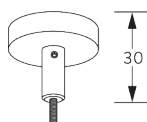
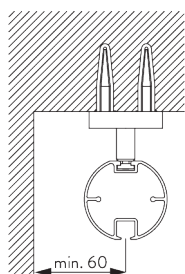

SG 20335
Support Top Fix

C. FIXATION
MURALE

Smart Fix

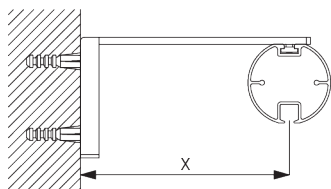

Smart Fix avec fente SG 11206 - SG 11208 et support
SG 6141:
Vis SG 20798 (M4x10) nécessaire.

Smart Fix	X mm
SG 11206 / SG 11216	51
SG 11207 / SG 11217	71
SG 11208 / SG 11218	91
SG 11209 / SG 11472	80-100

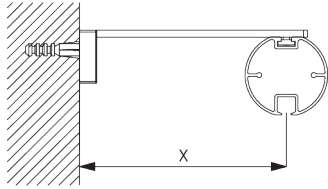

Square Smart Fix avec fente SG 11216 - SG 11218 et support SG 6141:

Vis SG 20798 (M4x10) nécessaire.

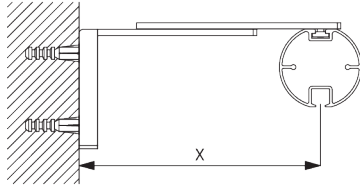

Smart Fix réglable SG 11209 et support SG 6141:

Vis SG 6784 (M4x8) nécessaire.

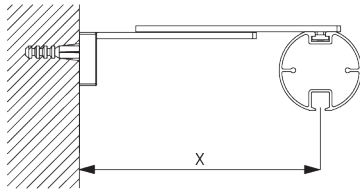

Square Smart Fix réglable SG 11472 et support SG 6141:

Vis SG 6784 (M4x8) nécessaire.

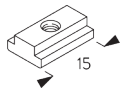

SG 6141

Ecrou fixation



SG 6784

Vis M4x8 mm

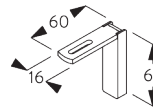

SG 11206

Smart Fix 60 mm avec fente

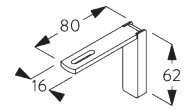

SG 11207

Smart Fix 80 mm avec fente

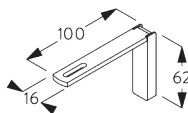

SG 11208

Smart Fix 100 mm avec fente

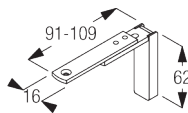

SG 11209

Smart Fix réglable

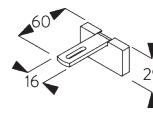

SG 11216

Square Smart Fix 60 mm avec fente

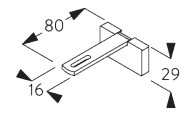

SG 11217

Square Smart Fix 80 mm avec fente

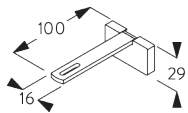

SG 11218

Square Smart Fix 100 mm avec fente

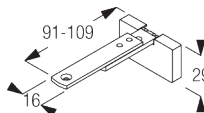

SG 11472

Square Smart Fix réglable



SG 20798

Vis M4x10 mm

Support réglable maxi SG 20334

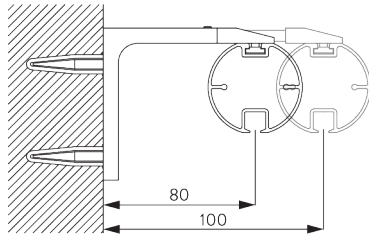

Vis SG 20798 (M4x10) nécessaire.

Note: tous les Metropole 50 mm sont livrés en standard avec le support réglable maxi SG 20334.

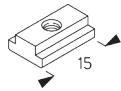

SG 6141

Ecrou fixation

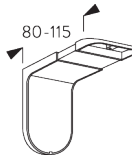

SG 20334

Support réglable maxi



SG 20798

Vis M4x10 mm

Support Blok SG 20989

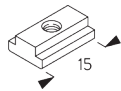
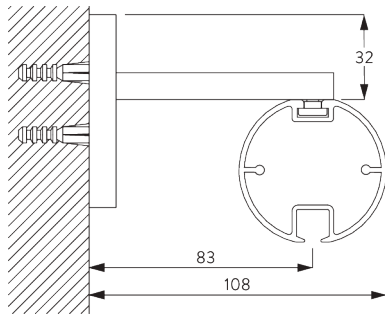

SG 6141

Ecrou fixation

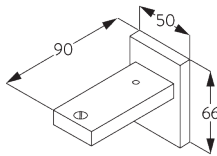

SG 20989

Support Blok

OPTIONS DÉSIGN

A. EMBOUTS

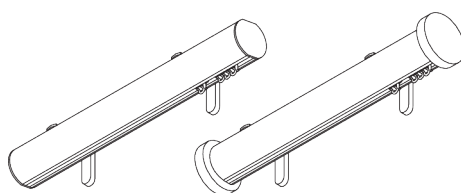

Sans embouts décoratifs, les profils sont fournis en standard avec l'embout Flush SG 20350 (gauche)

Alternativement, les embouts Stud SG 20714 (droite) sont disponibles sans surcoût.

B. EMBOUTS DÉCORATIFS

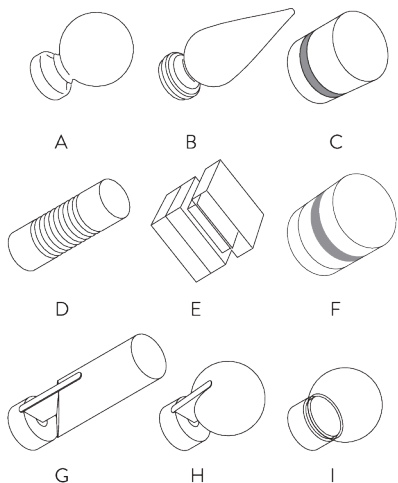
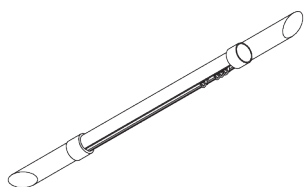

Les embouts décoratifs se fixent aux extrémités du profil.
Se référer à la brochure Metropole pour tous les détails de la gamme.

- A: SG 20717 Ball End 125mm
- B: SG 20718 Real Wood Spear 150mm
- C: SG 20697 Stata 65mm
- D: SG 20630 Groove Cylinder 125mm
- E: SG 20898 Crystal Cube 55mm
(Green, black, brown)
- F: SG 20899 Crystal Cylinder 55mm
(Green, black, brown)
- G: SG 20315 Fused Barrel 121mm
(walnut, oak, couleurs assorties)
- H: SG 20327 Fused Barrel 81mm
(walnut, oak, couleurs assorties)
- I: SG 20333 Glass Ball 70mm
(clear, frosted)

C. WAVE

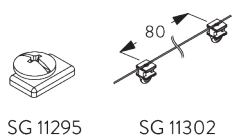
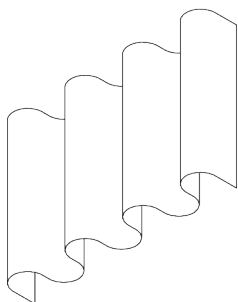

SG 11295

SG 11302

Composants standards:

- SG 11295 Vis d'arrêt
- SG 11302 Glisseur bi-composants 20 mm

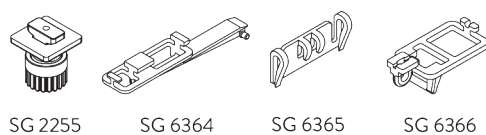

SG 2255

SG 6364

SG 6365

SG 6366

Composants en option:

- SG 2255 Frein
- SG 6364 Extension Wave
- SG 6365 Crochet Wave
- SG 6366 Chariot Wave pour lance rideau
- SG 10430-34 Lance rideau
- SG 11303 Glisseur Wave bi-composants 60 mm

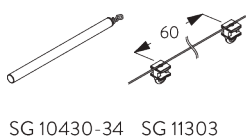

SG 10430-34

SG 11303

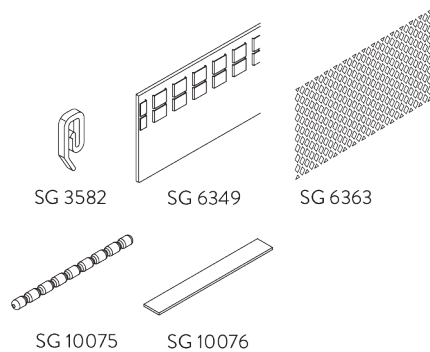

Composants de rideaux:

- SG 3582 Crochet
- SG 6349 Ruban Wave transparent
- SG 6363 Ruban à repasser
- SG 10075 Fil à plomb 50 gr/m
- SG 10076 Barre de lestage

Paquet rideau Wave - Glisseur Bi-composants (standard)

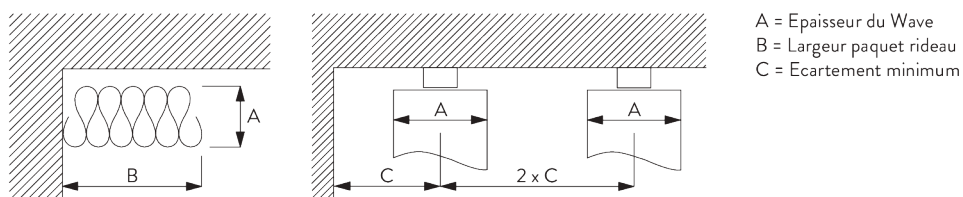

Glisseur Bi-composants SG 11302	Nombre de poches entre crochets	Ampleur rideau Approximative	Epaisseur du Wave A	Largeur paquet rideau B*	Ecartement minimum C
80	6	~2.1	140	180 mm par ml de tringle	90
80	7	~2.3	160	180 mm par ml de tringle	100

Glisseur Bi-composants SG 11303	Nombre de poches entre crochets	Ampleur rideau Approximative	Epaisseur du Wave A	Largeur paquet rideau B*	Ecartement minimum C
60	4	~2.1	100	230 mm par ml de tringle	70
60	5	~2.3	120	230 mm par ml de tringle	80

*Paque rideau B lors de l'utilisation du bras d'extension en option augmente de 95 mm par rideau!

INFORMATIONS GÉNÉRALES

Dimensions

- Mesures en mm sauf indication contraire.
- Le poids maxi inclus le tissu et les accessoires.
- La taille du paquet rideau dépend de la confection et de l'épaisseur du tissu.
- Distance maxi entre glisseurs 80 mm / Distance maxi entre rouleurs 100 mm.
- Ecart recommandé entre bas du rideau et le sol: 20 mm.
- Pour déterminer la hauteur du système (B), la hauteur la plus petite doit être prise en compte.

Installation

- Installation par poseur qualifié.
- Nombre de supports et points de fixation dépendent du poids du tissu, de la surface de pose, des vis utilisées et des obstacles.
- Les poseurs doivent utiliser les fixations appropriées à chaque situation.
- La lèvre du profil si elle existe doit être installée vers l'intérieur pièce.

Sécurité enfant

- Tous les systèmes Silent Gliss concernés répondent à la norme sécurité EN 13120.
- Tous les intervenants doivent être en conformité avec la norme EN 13120.

ACCESSOIRES

A. ACCESSOIRES STANDARDS



SG 6065
Fixateur avec oeillet



SG 6141
Ecroû fixation



SG 6143
Glisseur 6144 en barrette de 20



SG 11300
Glisseur Bi-composants



SG 20350
Embout 50 mm

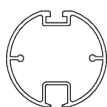

SG 20700
Profil 50 mm

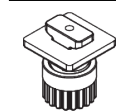

SG 2255
Frein



SG 3582
Agrafe Delrin

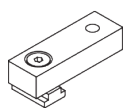

SG 6152
Support 9 mm



SG 6283
Rouleau



SG 6349
Ruban Wave transparent



SG 6363
Ruban à repasser

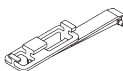

SG 6364
Extension

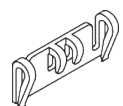

SG 6365
Crochet Wave

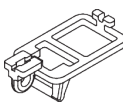

SG 6366
Chariot pour lance rideau

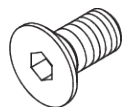

SG 6784
Vis M4x8 mm

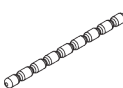

SG 10075
Fil à plomb 50 gr/m



SG 10076
Barre de lestage

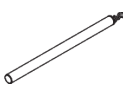

SG 10430
Lance rideau aluminium avec crochet, 50cm

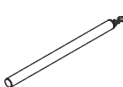

SG 10431
Lance rideau aluminium avec crochet, 75 cm

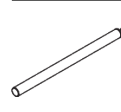

SG 10432
Lance rideau aluminium avec crochet, 100 cm

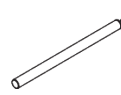

SG 10433
Lance rideau aluminium avec crochet, 125 cm

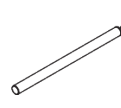

SG 10434
Lance rideau aluminium avec crochet, 150 cm

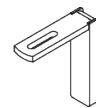

SG 11206
Smart Fix 60 mm avec fente

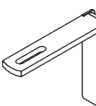

SG 11207
Smart Fix 80 mm avec fente

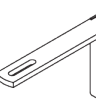

SG 11208
Smart Fix 100 mm avec fente



SG 11209
Smart Fix réglable

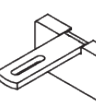

SG 11216
Square Smart Fix 60 mm avec fente

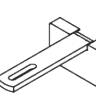

SG 11217
Square Smart Fix 80 mm avec fente

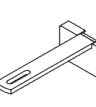

SG 11218
Square Smart Fix 100 mm avec fente



SG 11295
Arrêt



SG 11301
Glisseur Bi-composants en barrette



SG 11302
Glisseur Wave Bi-composants 80 mm



SG 11303
Glisseur Wave Bi-composants 60 mm

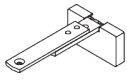

SG 11472

Square Smart Fix réglable

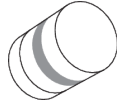

SG 20899

Crystal cylinder 55 mm

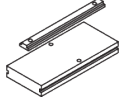

SG 20273

Jeu de ponts de connexion

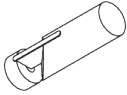

SG 20315

Fused barrel 121 mm

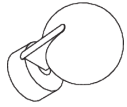

SG 20327

Fused ball 81 mm

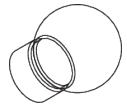

SG 20333

Glass ball 70 mm



SG 20334

Support réglable maxi



SG 20335

Support Top Fix

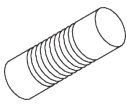

SG 20630

Groove cylinder 135 mm

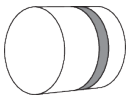

SG 20697

Strata 65 mm



SG 20714

Embout Stud 50 mm

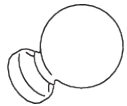

SG 20717

Ball end 125 mm



SG 20718

Real wood spear 150 mm

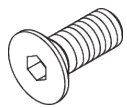

SG 20798

Vis M4x10 mm

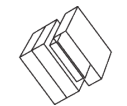

SG 20898

Crystal cube 85 mm

