

# SG 1014

---

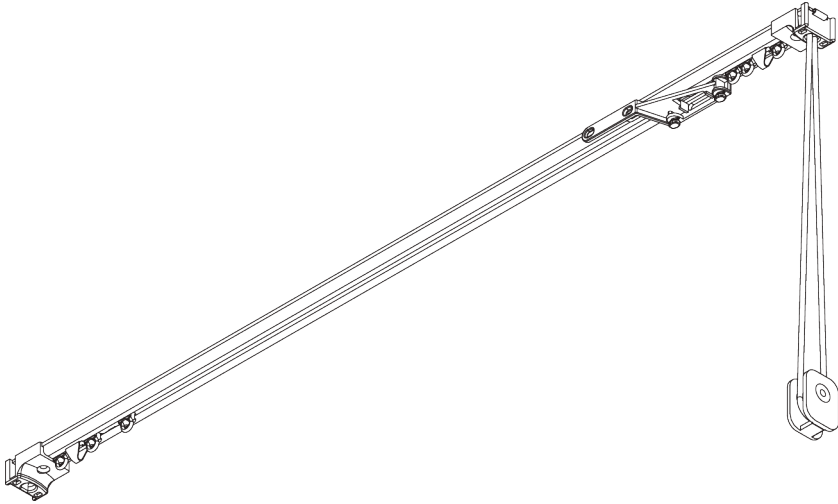
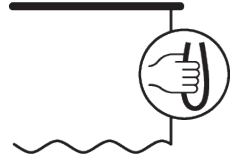

## INFORMATION PRODUIT

- **Mode de commande:** Tirage cordon
- **Gamme:** S
- **Installation:** Plafond
- **Couleurs:** Blanc RAL 9016 ou Aluminium, couleurs spéciales possibles
- **Tissus:** Se référer à la collection tissu Silent Gliss

### **Caractéristiques:**

- Profil prépercé
- Cintrable
- Outil d'installation SG 7550

# SPÉCIFICATION SYSTÈME

## A. DIMENSIONS SYSTÈME

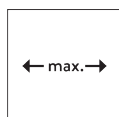

6 m

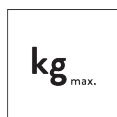

11 kg

## Poids maximum du rideau

	2 m	4 m	6 m
	8	7	6
	11	10	8
	5	4	-
	6	5	-
	3	2	-
	5	4	-

(kg max.)

## B. PROFIL

### Profil et information de cintrage

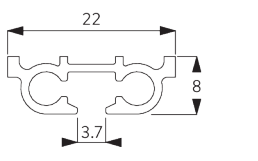

SG 1014p

Profil

✓ Rayon:  
20 cm

## C. PRISE DE MESURE

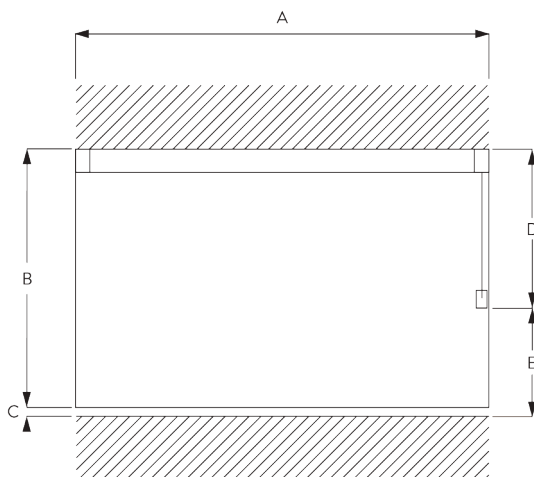

A: Largeur système

B: Hauteur système

C: Distance entre bas du rideau et le sol

D: Hauteur corde

E: Sécurité SG 10731. min. 150 cm du sol

# INSTALLATION

## A. INSTRUCTION DE POSE

Pour des informations détaillées, se référer au site web Silent Gliss.

### Points de fixation

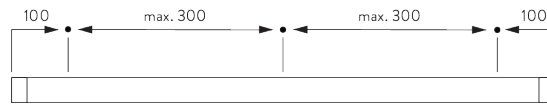

### Outils d'installation

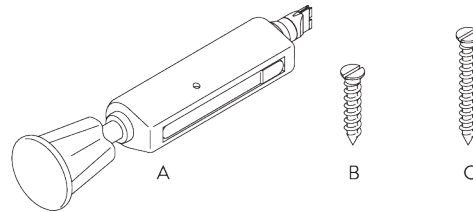

A: Outil Center SG 7550 Tool  
B: Vis SG 3019 / 12 mm  
C: Vis SG 3025 / 18 mm

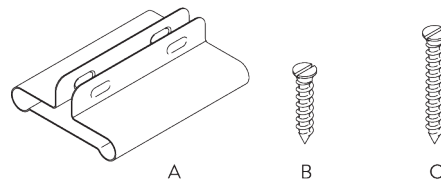

A: Outil de protection du profil SG 7002  
B: Vis SG 3019 / 12 mm  
C: Vis SG 3025 / 18 mm

## B. FIXATION PLAFOND

Fixation directe dans le bois

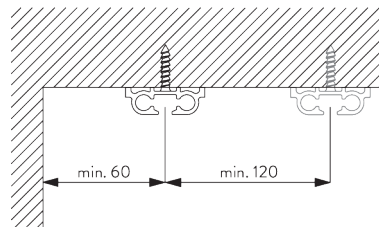

### Support SG 3114

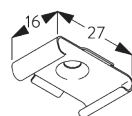
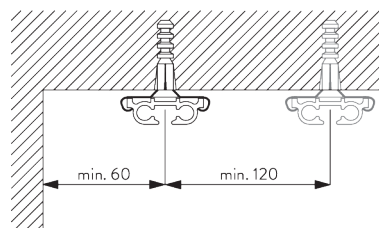

SG 3114  
Support plafond

# ACCESSOIRES

## A. ACCESSOIRES STANDARDS

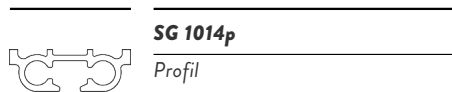

**SG 1014p**

Profil

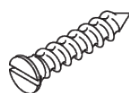

**SG 3019**

Vis à bois 12 mm

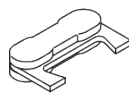

**SG 3030**

Conducteur

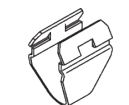

**SG 3085**

Ressort d'arrêt



**SG 3090**

Corde ø 3.5 mm

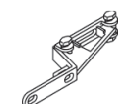

**SG 3242**

Chariot croisant



**SG 3533**

Glisseur

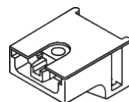

**SG 3714**

Poulie



**SG 10731**

Poulie de sécurité pour chaîne & cordon

## B. ACCESSOIRES EN OPTION

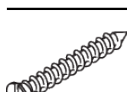

**SG 3025**

Vis à bois 18 mm

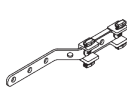

**SG 3045**

Chariot croisant



**SG 3070**

Fixateur avec œillet

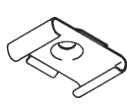

**SG 3114**

Support plafond



**SG 3340**

Contrepoids



**SG 3534**

Glisseur 3533 en barrette de 20 unités



**SG 3582**

Agrafe Delrin



**SG 3735**

Tendeur

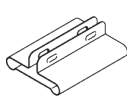

**SG 7002**

Protecteur de profil

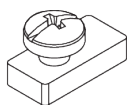

**SG 11335**

Arrêt